



Instruction Manual

Log-Ex 1000



Contence

	Page
1.	Application 25
2.	Safety information 25
3.	Malfunctioning and inadmissible operation 25
4.	Safety regulations 26
5.	Ex data 27
6.	Technical data 27-29
7.	Functional description +operating instructions 30
7.1.	Description of the Log-Ex 1000 30
7.2.	Introduction 31-32
7.3.	Commissioning the Log-Ex 1000 33-34
7.4.	Configuration the Log-Ex 1000 34-35
7.5.	Scaling the current and voltage values 36
7.6.	Charging the accumulators 37
7.7.	Storage 37
7.8.	The connections of the Log-Ex 1000 38
7.9.	The operating keys of the Log-Ex 1000 39
7.10.	Read-out and evaluating the measurements 40
7.11.	Graphical evaluation of measurements 41-42
8.	Repairs 42
9.1	Cleaning and Maintenance 42
10.	Guarantee and Liability 43
11.	Declaration of EC-Conformity 44
12.	EC Type-Examination Certificatel 45-46
13.	Approval Report 47

1. Application

The Log-Ex 1000 is a data logger for the acquisition of voltage, current and temperature values in explosion endangered areas (excluding firedamp endangered underground mining) of zones 2 and 1 in accordance with IEC/CENELEC [TÜV – (Technical Surveillance Organisation) approval] as well as zones 2, 1 and 0 as per NEC (FM approval).

2. Safety information

Safe operation of the equipment is maintained providing that all instructions and warnings contained in this manual are fully observed.

Before using the the appliance, read the operating instructions

In case of doubt (due to translation and/or printing errors) reference should be made to the original German instruction manual.

3. Malfunctioning and inadmissible operation

If there is any reason to suspect that the safety of the unit has been affected then it must be immediately withdrawn from use and precautionary measures taken in order to prevent any further use of in the hazardous area.

Safe use of the equipment could be endangered, for example, by :

- *visible damage to the outside of the housing*
- *the unit being subjected to improper strain*
- *the unit being improperly stored*
- *the unit being damaged in transit.*
- *lettering on the unit being unreadable*
- *occurrence of malfunctioning*
- *obviously inaccurate readings being produced*
- *inability of the unit to make any measurements*
- *the permissible limiting values being exceeded*

4. Safety regulations

The use of the intrinsically safe data Logger meets the requirements of the regulations providing that the user observes and applies the requirements as laid down in the regulations and that improper and incorrect use of the unit is avoided.

- **Charging may only be done outside the explosion-endangered area with the Type LG 40 charger.**
- **The accumulator may only be replaced by the manufacturer.**
- **The LG-Ex 1000 may only be connected to the RS-232 interface outside the explosion-endangered area. After carrying out such an operation, the equipment may only be returned to the explosion-endangered after a 30 minute retention period.**

5. Ex-Data



EC Certificate of Conformity: TÜV 98 ATEX 1318 X
Certification: II G EEx ia IIC T4

Permitted for Zone 1, Equipment group II, Gas group C hazardous gases, vapour or mist, Temperature Class T4

Report Job Identifikation No.:3009964
FM Marking: Class I Zone 0 AEx ia IIC T4
I.S. Class I Division 1 Group A-D T4

Permitted for Zone 0, Equipment group II, Gas group C,
Temperature class T6

6. Technical data

Operating temperature: - 10°C to + 40°C (14...104°F)
Storage temperature: - 20°C to + 50°C (-4...122°F)
Relative humidity: 0 to 90 % r.h.without condensation
Power supply: Rechargeable Ni-Mh accumulator
Housing: robust metal housing
Dimensions: 210 x 90 x 40 mm
Weight: approx. 770 g
Protection class: IP 65
Temperature measurement: PT 100
Interface socket: RS 232
Measured value storage: max. 200000 calwes
Measurement interval: 1s...24h
Operating time: approx. 90 days by measuring interval 1min
CE-Marking: 0102



EC Certificate of conformity

Current, voltage or
temperature

measurement input: EEx ia IIC
 $U_o = 6 V$
 $I_o = 8,4 mA$
Characteristic: linear

certified intrinsically safe circuit

$U_i = 30 V$
 $I_i = 300 mA$
max. permissible external capacitance: 66 nF
max. permissible external inductance: 0,2 mH

Interface circuit: $U_m = 250 V$
use only outside the hazardous area.

FM-Conformity

Output parameters: $U_o = 6,6 V$
 $I_o = 1,5 mA$
 $P_o = 2,5 mW$

Group IIC (Class I, Division 1, Groups A&B):
 $C_a = 22 mF$
 $L_i = 1 H$

Input parameters: $U_i = 30 V$
 $I_i = 300 mA$ $C_i = 0$
 $P_{max} = 2,25 W$ $L_i = 0$

Specification

Voltage

Range: 0,000 to +2,500V (unipolar)
-2,500 to +2,500V (bipolar)
Resolution: 1 mV
Accuracy: $\pm 0,1\%$ ± 1 Digit (0....40°C, 32...104°F)

Current

Range: 0,00 to 25,00 mA
Resolution : 10 μ A
Accuracy : $\pm 0,1\%$ ± 1 Digit (0....40°C, 32...104°F)

Pt 100

Range: 100,0 to +500,0°C (-148,0 bis 932,0°F)
Resolution : 0,1°C (0,1°F)
Accuracy : $\pm 0,4$ K (0....40°C, 32...104°F)

7. Functional description and operating instructions

7.1. Illustration of Log-Ex 1000

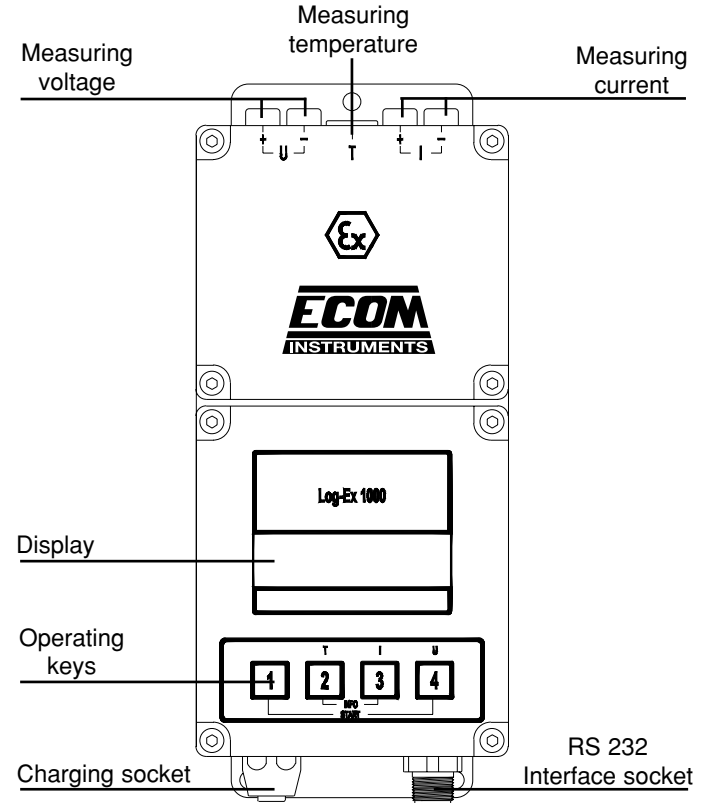

7.2. Introduction

The Log-Ex 1000 you have purchased is an instrument that allows you to quickly and safely measure temperatures, voltages and currents in intrinsically safe circuits.

Functions of the Log-Ex 1000

The Log-Ex 1000 allows combinations of voltage, current and temperature to be measured in various configurations. The operating status and various special functions described in Section 7.9 can be called up using the operating elements on the front of the instrument.

Functions of the Log-Ex 1000 configuration and read-out software.

The required settings for the Log-Ex 1000 can be programmed using the configuration software (see Section 7.4).

This data is transmitted to the Log-Ex 1000 via the RS 232 interface (see Section 7.3).

The readout software allows the measurements to be displayed and post-processed graphically (see Section 7.11).

Installation

To install the configuration and read-out software, start the SETUP.EXE programme and follow the instructions. We recommend that all WINDOWS programmes be closed before starting to install the programme.

System requirements

In order to be able to run the configuration and read-out software of the Log-EX 1000, the minimum equipment you will need is a Pentium processor with 75 MHz clock frequency and an 8 MB working memory as well as a hard disc with 2 MB free space. The software needs the WINDOWS 95 (or higher) operating system or WINDOWS NT. A free serial interface and data cable are required for the connection of the data logger to the PC.

7.3. Commissioning the Log-Ex 1000

Preparation:

Connect the cable between the serial interface and the instrument.

Attention!

The operating keys cease to function once the Log-Ex 1000 is connected to the serial interface.

Start programme ECOM.EXE

After calling up this programme, the control window appears from where all actions are started.

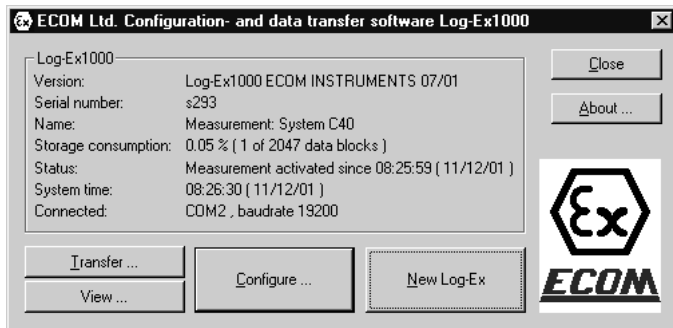

Transfer: The measured data is read from the Log-Ex1000 and stored.

View: The Log-Ex 1000 graphics program is started.

Configure: The Log-Ex 1000 configuration menu is started.

New Log-Ex: A newly connected Log-Ex 1000 data logger is initialised.

7.4. Configuring the Log-Ex 1000

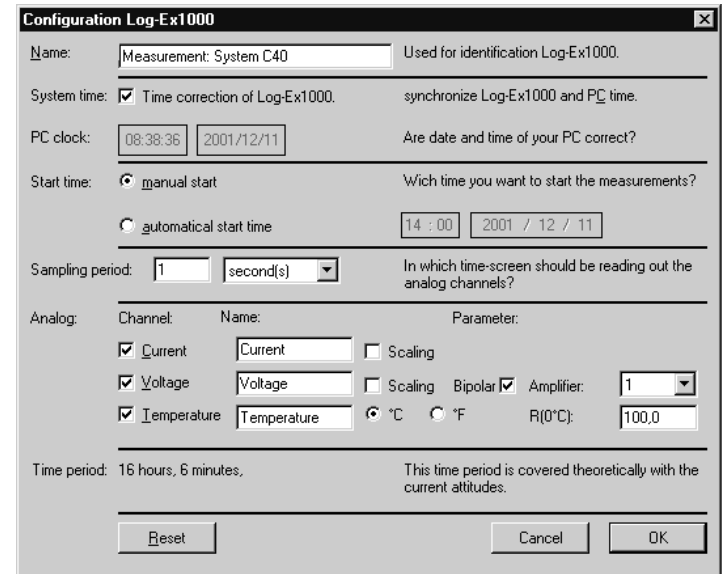

Functions:

Name: Enter a name to identify your measurements.

System time: This synchronises the system time of your PC with the Log-Ex 1000.

PC clock: Check field giving information about your PC data.

Start time: **manual start** (see Section 7.9) The measurement can be started immediately after configuration or at a time you choose yourself. **automatic start time.** The measurement starts at the time you have chosen.

Measuring period: You can enter here any time basis you like in seconds, minutes and hours. (max. recording time approx. 80 days).

Analog:
Channel: select the desired measurement(s)
Scaling: is described in the next section
Bipolar: measuring range is offset between -2.5V and +2.5V
Amplification: The sensitivity is increased with the "scaling" function whereby the input voltage is to be taken into account:

Amplification	max. input voltage
1	2,50 V
2	1,25 V
4	0,62 V
8	0,31 V
16	0,15 V

°C / °F: Choice of the temperature unit °C or °F
R(0°C): Enter a correction value for compensation.
Time period: Details of the theoretical time period during which recording of the selected measurements is possible.

7.5. Scaling the current and voltage values

This gives you the option to record and store the current and voltage in a user-defined physical unit

Scaling Log-Ex1000

Voltage

Minimum: 0,000 V equal to 0,000 Unit: mBar

Maximum: 2,000 V equal to 20,00 Unit: mBar

Abbrechen OK

Scaling Log-Ex1000

Current

Minimum: 0,00 mA equal to 0,00 Unit: A

Maximum: 20,00 mA equal to 2,00 Unit: A

Abbrechen OK

Explanation of the input fields:

Minimum: Enter the minimum current/voltage value.
Corresponds to: Enter the desired physical value.
Maximum: Enter the maximum current/voltage value.
Corresponds to: Enter the desired physical value.
Unit: Enter the physical unit.

7.6. Charging the accumulators

To guarantee optimum operating time, the accumulator must be fully charged before values can be measured with the data logger.

- Connect the LG40 charger to the Log-Ex 1000.
- Charge the accumulator until the "accu. full" LED lights up. The charger switches over to trickle charge.
- Check the accumulator capacity of the Log-Ex with keys 2 + 3.
- Should the capacity be less than 550 mAh, the Log-Ex 1000 should continue to be charged by the LG40 until the accumulator capacity display shows 550 mAh.
- When the "accu. full" LED is lit and the accumulator capacity displays shows 550 mAh, then the accumulator is fully charged.

Attention!

The charging of the cells with the Type LG40 charger may only be done outside the explosion-endangered areas!

7.7. Storage

The Log-Ex 1000 should only be stored with fully charged accumulators (see 7.6). In order to keep the current consumption in standby mode as low as possible

- the temperature sensor should be disconnected.
- the Log-Ex should be configured as follows (channels: none, measuring period: 24 hours).
- the Measurements should not be started.

If the equipment has to be stored for a lengthy period, then the accumulator should be recharged every month.

7.8 The connections of the Log-Ex 1000

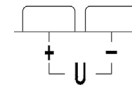

Measuring voltages with the Log Ex 1000

Voltage measurement sockets on the Log-Ex 1000
The voltage to be measured is connected to these sockets.

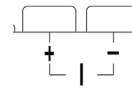

Measuring current

Current measurement sockets on the Log-Ex 1000
The current measurement signal is connected to these sockets.

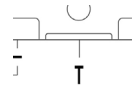

Measuring temperatures

Temperature measurement sockets on the Log-Ex 1000. The Pt 100 temperature sensor is connected to these sockets.

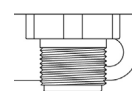

Connecting the interface cable to the Log-Ex 1000

This socket is for the interface cable to allow communication with the PC and the configuration and readout software.

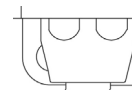

Charging socket on the Log-Ex 1000

To connect the charging cable for the Log-Ex 1000

7.9 The operating keys of the Log-Ex 1000

Various functions are assigned to the 4 keys on the Log-Ex 1000 as described below.

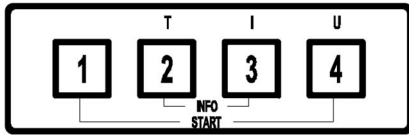

1

Displays the operating status of the measurement.

2

Displays the actual temperature value.

3

Displays the actual current value.

4

Displays the actual voltage value.

1

4

If manual start is selected in the configuration menu, measurement is started by pressing these two keys simultaneously.

2

3

The battery capacity is displayed for information purposes by pressing these two keys.

7.10. Reading and evaluating the measurements

Preparation:

Connect the cable between the serial interface and the instrument.

Attention!

The operating keys cease to function once the Log-Ex 1000 is connected to the serial interface.

Start programme ECOM.EXE

After calling up this programme, the control window appears from where all actions are started.

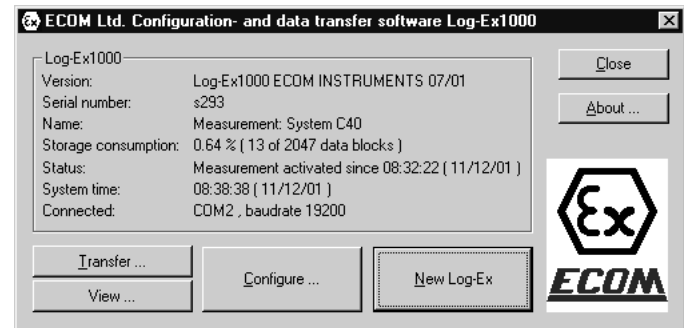

Now select "Transfer" to start sending data from the Log-Ex 1000. The data is stored in two different formats.

The data is stored in Log-Ex 1000 format and in Excel format in a user-defined directory with the name you specify.

When you have made this selection, the data is transmitted from the Log-Ex 1000 to the specified directory.

7.11. Graphical evaluation of measurements

Start the ECOMGR.EXE programme or select the "view" point in the control window.

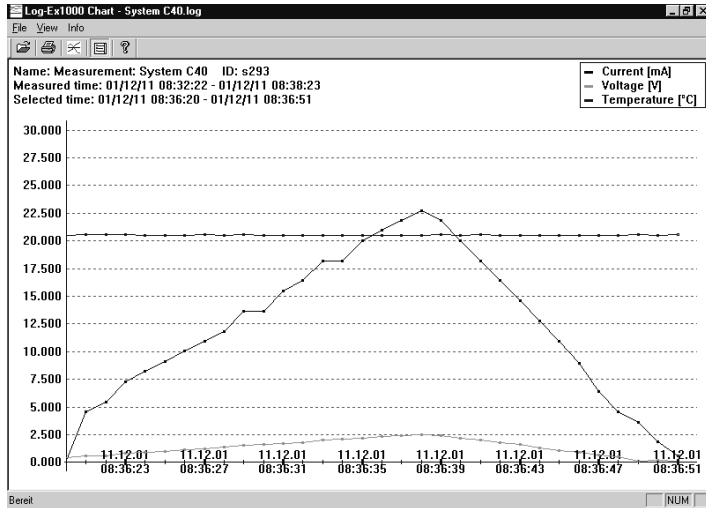

Functions:



-Open new measurement file.



-The graphic displayed will be printed immediately.



-The displayed graphs can be changed.



-The legend can be deleted or inserted.



-Information about the Log-Ex 1000 graphics program.

Information:

Name:

Identifies your measurements.

ID:

Identifies the Log-Ex 1000 used for the measurements.

Period recorded: Total duration of the Log-Ex 1000 recording period.

Period shown: The measuring period shown in the graphic.

Zoom functions: Pressing the left mouse key opens a window that is zoomed into when the key is released. This zoom function can display data to a resolution of 1 second on the time axis. Pressing the right mouse key displays of the total Log-Ex 1000 recording period again.

8. Repairs

The conditions of ELEX V are valid for repairs. We recommend the repairs take place at the manufacturers since a safe technical examination is required when making repairs.

9. Cleaning and Maintenance

Equipment must only be cleaned with a damp cloth or sponge. Only use water and soapy water to clean. Solutions or scrubbing materials are not suitable for cleaning.

10. Guarantee and Liability

ecom instruments GmbH grants a guarantee, for a period of 2 years from the date of delivery, for the operation and material of this product under normal operating and maintenance conditions.

This guarantee does not apply to products used improperly, altered or neglected, or exposed to accidental damage or abnormal operating conditions as well as improper handling. Guarantee claims can only be granted if the defective equipment is returned to ECOM. We reserve the right to repair, modify or exchange any equipment.

The guarantee regulations are the only rights to compensation of a purchase and are valid above all other contracts or legal guarantee duties. ECOM takes no responsibility for any consequential damages or losses, including the loss of data, independent of whether legal or illegal actions, or actions treated as other handling, can be traced back to violation of the guarantee.

In the case of some countries, where the restrictions of a legal guarantee as well as the exception or restriction of consequential damage is not permitted, it could be that the above mentioned limitations and exceptions are not valid for every purchase. Should an appropriate court find any condition of such regulations ineffective or non-acceptable, the effectiveness or forcibility of any other condition, under such guarantee regulations, remains untouched.

11. EC Declaration of conformity

We

ecom instruments GmbH

Industriestraße 2
D-97959 Assamstadt

declare under our sole responsibility that the produc

Log-Ex 1000

to which this declaration relates is in accordance with the provision of the following directives,

94/9/EG	Electrical apparatus for potentially explosive atmospheres
89/336/EWG	Electromagnetic compatibility

and is in conformity with the following standards or other normative documents.

EN 50014:1997	Electrical apparatus for potentially explosive atmospheres; General requirements
EN 50020:1994	Electrical apparatus for potentially explosive atmospheres; Intrinsic safety "i"
EN 50081-1:1993	Electromagnetic compatibility (EMC); Generic emission standard
EN 50082-1:1997	Electromagnetic compatibility (EMC); Generic immunity standard

ecom instruments GmbH
Assamstadt, den 10.12.01

Signature: Rolf Nied
Managing Director

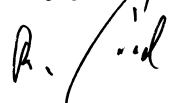

12. EC Type-Examination Certificate



Translation

EC TYPE-EXAMINATION CERTIFICATE

- (1) EC TYPE-EXAMINATION CERTIFICATE
- (2) Equipment or Protective System intended for use in potentially explosive atmospheres - Directive 94/9/EC
- (3) EC-Type Examination Certificate Number



TÜV 98 ATEX 1318 X

- (4) Equipment or Protective System: Data Logger Type Log-Ex 1000
- (5) Manufacturer: ECOM Rolf Nied GmbH
- (6) Address: Industriestraße 2
D-97959 Assamstadt

- (7) This equipment or protective system and any acceptable variation thereto is specified in the schedule to this certificate.
- (8) The TÜV Hannover/Sachsen-Anhalt e.V., TÜV Certification Body N° 0032 in accordance with Article 9 of the Council Directive of the EC of March 23, 1994 (94/9/EC), certifies that this equipment or protective system has been found to comply with the Basic Health and Safety Requirements relating to the design and construction of equipment and protective systems intended for use in potentially explosive atmospheres given in Annex II to the Directive.

The examination and test results are recorded in the confidential report N° 98/PX04880

- (9) Compliance with the Basic Health and Safety Requirements has been assured by compliance with:

DIN EN 50 014: 1997 DIN EN 50 020: 1994

- (10) If the sign "X" is placed after the certification number, it indicates that the equipment or protective system is subject to special conditions for safe use specified in the schedule to this certificate.
- (11) This EC-type examination certificate relates only to the design and construction of the specified equipment or protective system according to Directive 94/9/EC. Further requirements of this Directive apply to the manufacture and placing on the market of this equipment or protective system.
- (12) The marking of the equipment or protective system must include the following:

II 2 G EEx ia IIC T4

TÜV Hannover/Sachsen-Anhalt e.V.
TÜV CERT-Zertifizierungsstelle
Am TÜV 1
D-30519 Hannover

Hannover, 30.07.1998



i.v.d.
Head of the
Certification Body

This certificate may only be reproduced without any change, schedule included.
Excerpts or changes shall be allowed by the TÜV Hannover/Sachsen-Anhalt e.V.

page 1/2



(13)

SCHEDULE

- (14) **EC-TYPE EXAMINATION CERTIFICATE N° TÜV 98 ATEX 1318 X**

- (15) Description of equipment or protective system

The data logger type Log-Ex 1000 is used for measuring and storage of voltage-, current- and temperature values in explosion-hazardous areas.

Electrical data

Supply: U = 5,4 V; 580 mAh
(internal battery) 4 ea. nickel-hydride cells type VH 600 F6, Messrs. VARTA

Current-, voltage or temperature measuring inlet resp. in type of ignition protection intrinsic safety EEx Ia IIC
max. values U_o = 6 V
I_o = 8,4 mA
characteristic line: linear

or

for the connection at a certified intrinsically safe circuit
max. values: U_i = 30 V
I_i = 300 mA
max. admissible external capacitance 66 nF
max. admissible external inductance 0,2 mH

RS 232 Interface

U_m = 250 V
use only outside the explosion-hazardous area

- (16) Test documents are listed in the test report No.: 98/PX04880.

- (17) Special conditions

1. Charging of the cells must only be effected outside the explosion-hazardous area at the charging station type LG 40.
2. Battery change must only be effected by the manufacturer.
3. The connection of the RS 232 interface must only be carried out outside the explosion-hazardous area. After such a use the device must only be brought into the explosion-hazardous area after a retention time of 30 minutes.

- (18) Basic Health and Safety Requirements

no additional ones

page 2/2

12. EC Type-Examination Certificate

Factory Mutual Research

APPROVAL REPORT

**DATA LOGGER
LOG-Ex 1000
FOR HAZARDOUS (CLASSIFIED) LOCATIONS**

Prepared for:

**ECOM Rolf Nied GmbH
Industriestraße 2
D-97959 Assamstadt, Germany**

**Project ID. 3009964
Class 3610
Date: July 19, 2001**

Factory Mutual Research Corporation
1151 Boston-Providence Turnpike
P.O. Box 9102
Norwood, MA 02062

An  Affiliate



ecom instruments GmbH

Industriestr.2
D-97959 Assamstadt

Tel.: +49 (0) 62 94/42 24 0
Fax: +49 (0) 62 94/42 24 90

E-Mail: sales@ecom-ex.com
Internet: www.ecom-ex.com